

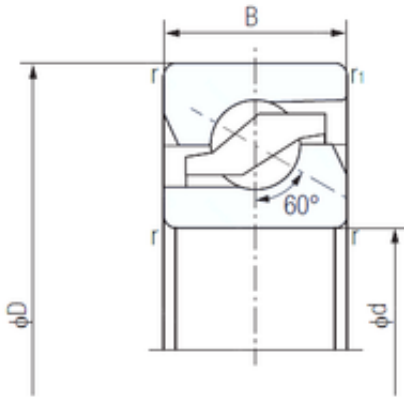

Bearing machinery corp.

25 mm x 62 mm x 15 mm nachi 25tab06 bearing



25tab06 Bearing 2D drawings and 3D CAD models

Bearing No. 25tab06

Size	25x62x15 mm
Bore Diameter	25 mm
Outer Diameter	62 mm
Width	15 mm
d	25 mm
D	62 mm
B	15 mm
C	15 mm
Angle ()	60 °
r min.	1 mm
r1 min.	0,6 mm
Weight	0,24 Kg
Basic dynamic load rating (C)	29,9 kN
Basic static load rating (C0)	46,4 kN
(Grease) Lubrication Speed	4650 r/min
Enclosure	Open
Configuration	Single Row
Bore Type	Cylindrical Bore
Bore Size	25 mm
Outside Diameter	62 mm
Width	15 mm
Fillet Radius/Chamfer	1 mm
r1	0.6 mm
a	0 mm
2B	30 mm
Dynamic Load Rating	29,900 N



Bearing machinery corp.

Static Load Rating	46,400 N
Limiting Speed - Grease	4,650 rpm
Limiting Speed - Oil	6,000 rpm
Starting Torque - Grease Lubrication	20 N · cm
da1 (min)	46.2 mm
da2 (min)	39.7 mm
Da1 (max)	46 mm
Da2 (max)	53.4 mm